

BALANCES

COUNTING SCALES

BENCH SCALES

CHECKWEIGHERS

CONVEYOR SCALES

FLOOR SCALES

INDICATORS

TRUCK SCALES

RAILROAD SCALES

BATCHING SCALE SYSTEMS

SOFTWARE

JUNCTION BOXES

FORKLIFT SCALES

MONORAIL SCALES

PRINTERS

REMOTE DISPLAYS

Avery Weigh-Tronix Batching Scale Systems



For bins, tanks and hoppers —
straight weighing or batching.
An accurate, easily set up scale system.

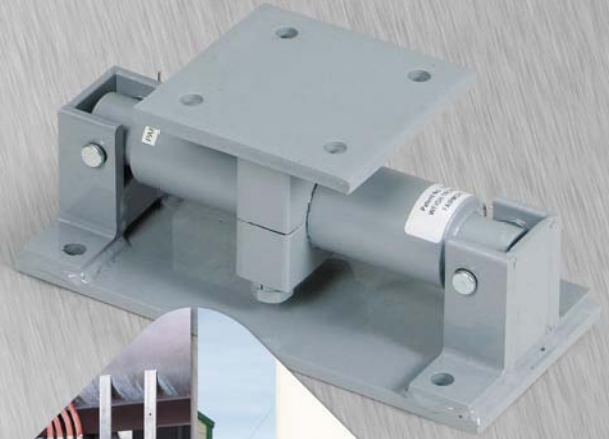

**BIN
TANK &
HOPPER**

Accurate, Reliable, Built to Last



Avery Weigh-Tronix

Avery Weigh-Tronix

*Are you tired of paying for excess handling of materials, of watching loads hauled from storage bins to distant scales, of inaccurate inventories due to questionable measurement by volume?
Is an automated batching system part of your future plans?*

Bins, tanks and hoppers transformed into accurate, dependable scales

Save steps, time and money by converting your existing bins, tanks or hoppers into accurate, dependable weighing systems with Avery Weigh-Tronix Weigh Bars and instrumentation.

Wide selection of Weigh Bars®

Avery Weigh-Tronix weighing systems come in sealable (Class III, 5,000d) and non-sealable (0.25% accuracy) versions with capacities from 125 to 200,000 pounds. Avery Weigh-Tronix offers Weigh Bars for both base-mounted and suspended installations.

Standard Weigh Bars are finished with epoxy paint for corrosion protection. Stainless steel versions¹ have also been developed for food processing and chemical applications. The chain link assemblies are well suited for food applications where thorough cleaning and sanitation are essential.

With its unique self-leveling chain link design, the Avery Weigh-Tronix Weigh Bar is ideal for hoppers and silos where vibration and off-center loadings can sometimes be a problem.

Fast, inexpensive installation

The Avery Weigh-Tronix bulk weighing systems can be installed quickly and easily, with minimum disruption of your normal business. There are no stay rods to install, no moving parts to adjust or balance.

Remote weight indication

The digital weight indicator can be installed anywhere you want it, at the weighing site or at a supervisory station up



to 400 feet away. In addition, accessory remote displays with large, 4-inch or 6-inch high digits are available.

Minimal servicing costs

Because the system is all electronic, with no shock-sensitive check rods or delicate moving parts to keep adjusted, maintenance is kept to a minimum. This saves you money, not only in service charges, but also in system downtime.

Multiple bin weighing

Optional selector boxes make it possible to monitor several bins, one at a time, with a single indicator.

Relays operate gates or valves, automatically

The Avery Weigh-Tronix bulk weighing system can be expanded with optional setpoints. These enable the basic system to control loading or unloading of containers with relays that are activated whenever preset weight readings are reached.

A SIMPLE SYSTEM

A Weigh Bar weight sensor is placed under each leg of the container (or at each suspension point for a hanging installation). As weight is placed on the Weigh Bar, the electrical current running through the bar is changed. The altered current from each Weigh Bar is brought to and combined at a junction box. From here it is carried by an interface cable to the indicator which converts the current to a digital weight display.

In addition to display weight, the indicator can also send signals that operate a variety of accessories.

As many as 12 Weigh Bars can be used in a system with the standard E1110 or E1310 indicator.

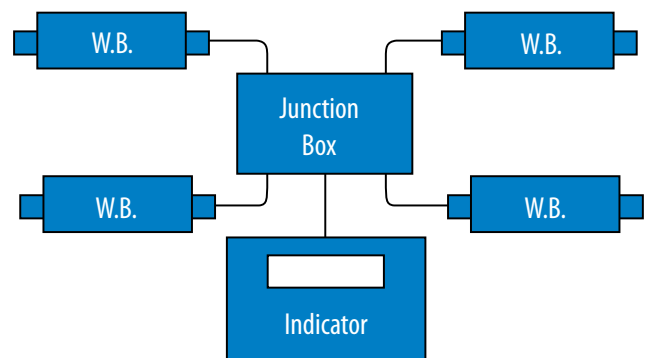

¹ Chain link assemblies and U-bolt assemblies are nickel plated steel.

Avery Weigh-Tronix Batching Scale Systems

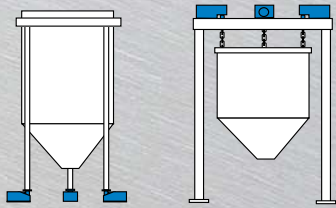

Avery Weigh-Tronix bulk weighing systems install quickly to existing equipment and fixtures with minimum disruption to your normal business.

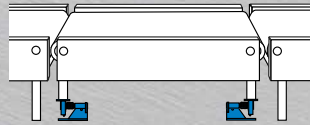
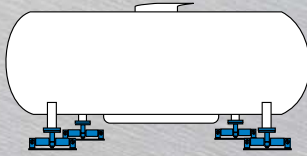

WEIGH BAR MODELS

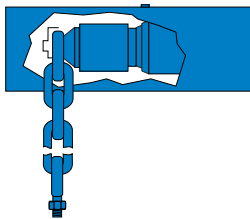

Sealable, Class III max. 5,000d tension bars are available in per bar capacities of 5,000 lb to 20,000 lb.

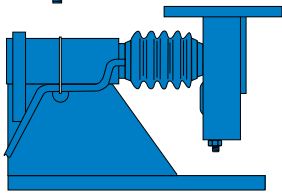

Stainless steel, sealable, Class III max. 5,000d compression bars are available in per bar capacities of 500 lb to 5,000 lb. Ideal for food and chemical applications.

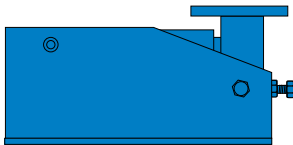

Sealable, Class III max. 5,000d compression bars are available in per bar capacities of 125 lb to 50,000 lb, self-leveling chain link design.

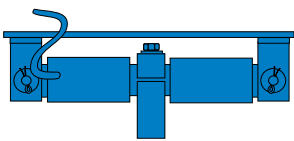

Non-sealable, .25% tension bars are available in per bar capacities of 250 lb to 25,000 lb.

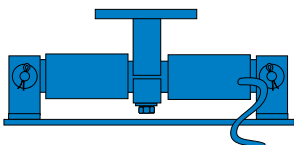

Non-sealable, .25% compression bars are available in per bar capacities of 250 lb to 200,000 lb.

TWO-YEAR WARRANTY

The Avery Weigh-Tronix Automated Bulk Weighing System and all optional and accessory equipment are warranted to be free from defects in material and factory workmanship for 24 months. (Other manufacturers offer only a 3- to 12-month warranty.) A warranty certificate accompanies each product.

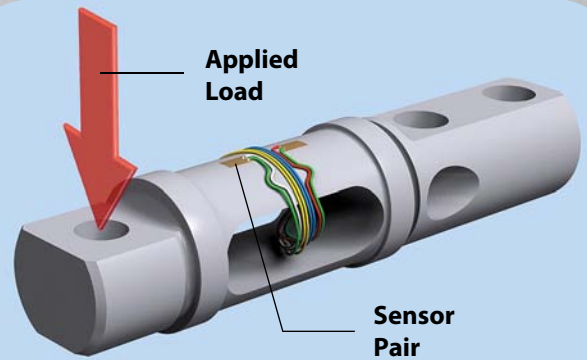

WEIGH BAR PRINCIPLES OF OPERATION

Measuring Applied Load

The Weigh Bar steel structure acts as a cantilever, unsuspended on one end and fixed on the other. A load is applied to the unsuspended end. The pair of sensors attached to the outside of the Weigh Bar detect strain in the bar. This strain is interpreted by indicator electronics to display a weight.

Error Reduction

The unique design of the Weigh Bar allows simple calculations to be made by the indicator, eliminating several types of errors:

- **End Loading** – When an end load is applied to the Weigh Bar, it is subjected to a uniform compressive strain throughout its length – all sensors detect the same strain.
- **Torsion Effects** – When torque is applied to the Weigh Bar, a uniform torsional shear strain is developed through the length of the bar – both sensors detect the same strain.
- **Side Loading** – When a side load is applied to the Weigh Bar, it acts as a beam, but at a 90-degree angle. When this occurs, the neutral axis of the beam (the point in the beam where neither tension or compression occur) falls directly under the center of the strain gauges. No apparent strain is seen by the gauges.
- **Vibration** – The fine grain structure of aircraft quality steel is resistant to vibration fatigue and induced error. The strain gauges and adhesive used are also vibration and fatigue proven.

Failure Rate

The Weigh Bar failure rate is extremely low, when compared to the competition:

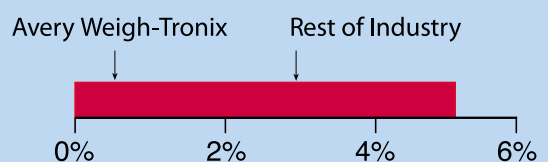



SPECIFICATIONS

General — The Avery Weigh-Tronix Automated Bulk Weighing System is a modular system that can be adapted to your specific requirements. Your Avery Weigh-Tronix dealer will prepare a system proposal based on what you expect from the system. Your order will then be turned over to Avery Weigh-Tronix engineers who will use your equipment's dimensional drawings to prepare installation instructions for the dealer. The system you purchase will consist of components with the technical specifications listed below.

Environment — The Automated Bulk Weighing System is designed to operate without modification in the vast majority of industrial and agricultural environments. Where caustic chemicals are present, batching bar components should be sealed in epoxy or otherwise protected by appropriate measures recommended by your Avery Weigh-Tronix dealer. In addition, Avery Weigh-Tronix offers stainless steel Weigh Bars for food and caustic chemical applications.

Optional enclosures — The Automated Bulk Weighing System's weight indicator may be ordered with a NEMA 4 watertight stainless steel enclosure. Alternatively, an explosion-proof enclosure may be specified for use in the presence of flammable gases or vapors.

Accuracy and compliance — When Accuracy Class III Weigh Bars are properly installed according to manufacturer's instructions, the Automated Bulk Weighing System meets the requirements of NIST Handbook No. 44, as applicable to digital weighing systems. Cert. Numbers for sealable Weigh Bars:

87-095 — 125- to 250-lb Weigh Bars
87-090.A3 — 500- to 50,000-lb Weigh Bars

Cable lengths — Standard length for both Weigh Bar and interface cables is 25 feet. Optional lengths may be specified.

Batching system Weigh Bars (Sealable only)

Recommended excitation voltage: 15V AC or DC
Maximum excitation voltage: 20V AC or DC
Input resistance: 350 Ohms +5%/-1%
Output resistance: 350 Ohms ±1%
Zero balance: ±1% of rated output

Output at rated capacity: 1.015 mV/V or 2.03 ±1%, depending on capacity
Non-linearity (maximum): .02% of rated output
Repeatability: .02% of rated output
Hysteresis (maximum): .03% of rated output
Creep (maximum): .05% of rated output in 1 hr
Temperature effect on output: (-10°C to +40°C): ±0.04% of rated output at 20°C
Temperature effect on zero balance: (-10°C to +40°C) 0.7 Vmin/5°C
Safe overloading rating: 150%
Maximum overload rating: 200%
Insulation resistance: 1010 ohms

OPTIONS

A wide range of options are available to supplement Batching Scale Systems. Some of these include:

Indicators, remote displays, ticket and tape printers, junction boxes and environmental protection covers and boots.



Avery Weigh-Tronix

Avery Weigh-Tronix - USA

1000 Armstrong Drive,
Fairmont, MN 56031-1439 USA
usinfo@awtxglobal.com
Toll-Free: (800) 533-0456
Phone: (507) 238-4461

Avery Weigh-Tronix - UK

Foundry Lane, Smethwick,
West Midlands B66 2LP UK
info@awtxglobal.com
Phone: +44 (0) 8453 66 77 88
Fax: +44 (0) 121 224 8183

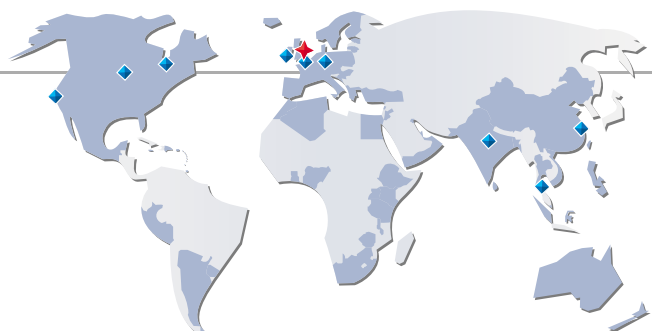

Please call us or visit www.averyweigh-tronix.com
for your nearest Avery Weigh-Tronix distributor

